

REV. 2

# OCEANUS 12 VST

515 - 3 - 2

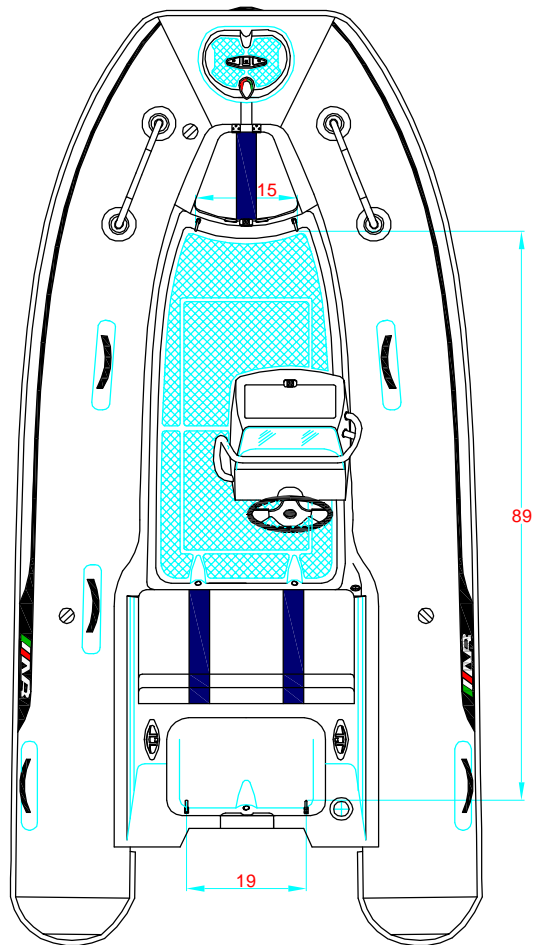

-LOCATION AND DISTANCE  
OF DAVIT LIFTING POINTS

UBICACION Y DISTANCIA  
DE LOS GANCHOS DE IZADO

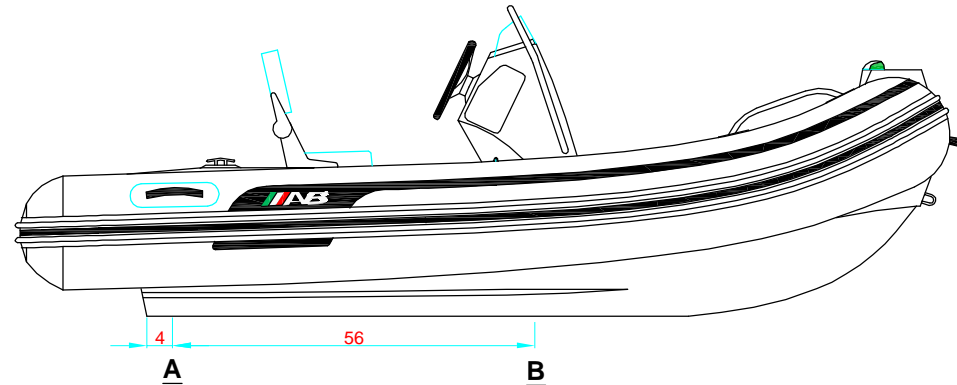

**LONGITUDINAL PROFILE**  
**VISTA LATERAL**

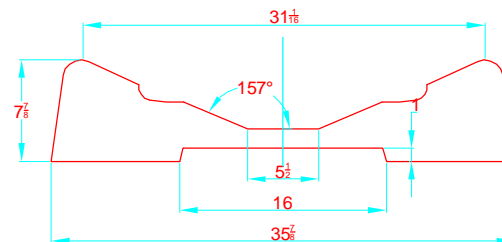

**TRANSVERSAL SECTION "A"**  
**SECCION TRANSVERSAL "A"**

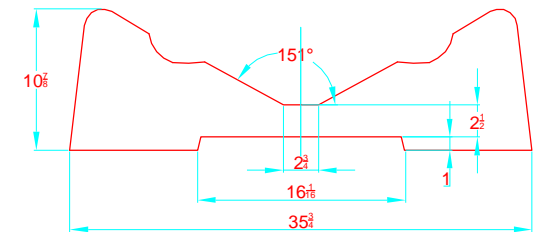

**TRANSVERSAL SECTION "B"**  
**SECCION TRANSVERSAL "B"**

-RECOMMENDED CHOCK LOCATION AND BUILDING DIMENSIONS  
UBICACION DE LAS CUNAS Y SUS MEDIDAS DE FABRICACION

-VERIFY MEASUREMENTS WITH ACTUAL HULL  
VERIFICAR MEDIDAS DE ACUERDO A CASCO ACTUAL

**NOTES:** 1.- ALL DIMENSIONS IN INCHES  
2.- MEASURES FROM CENTER OF CHOCK'S SURFACES